

KLAST

www.klasthome.com

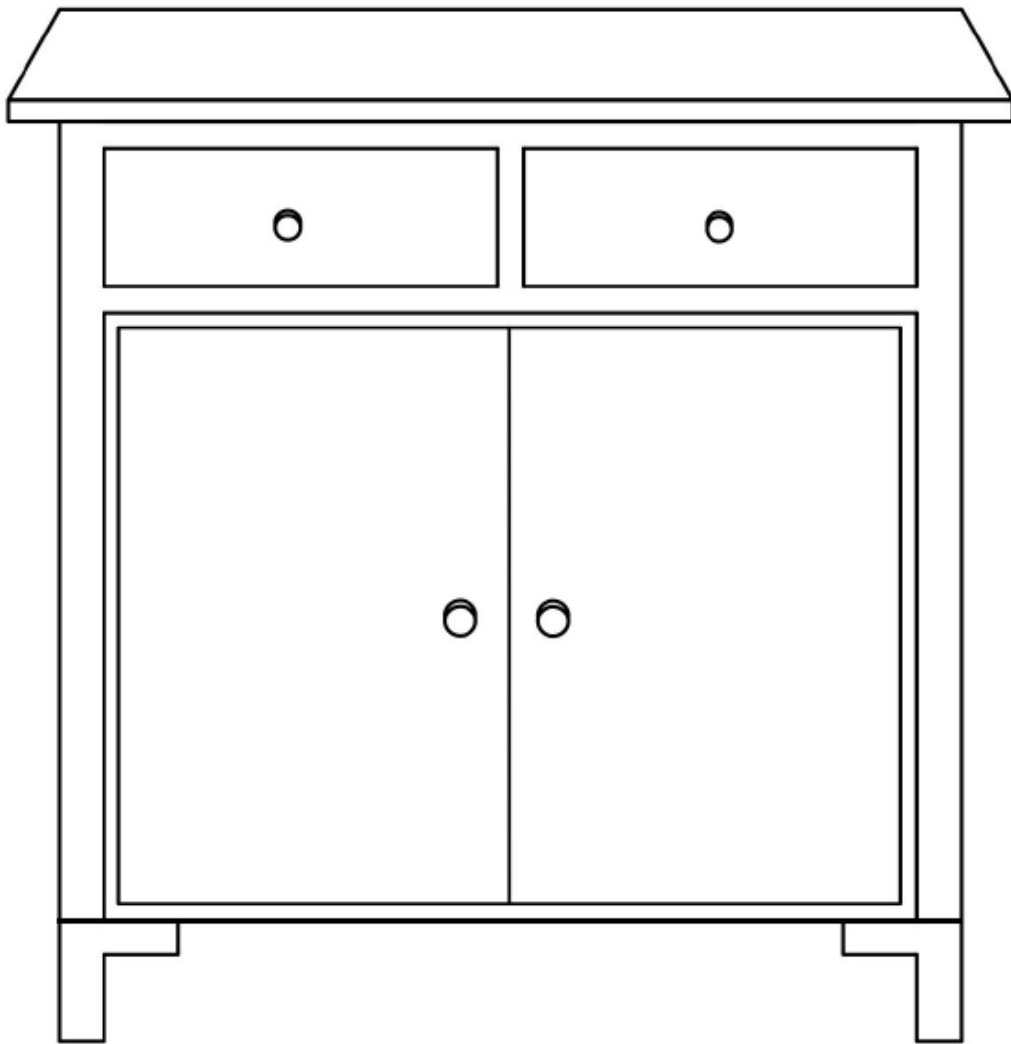

IRAYA

Ref: GN-0019

1/3

-V1.0-

KLAST

www.klasthome.com

MATERIAL

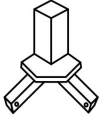

A x 1 PC

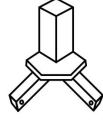

C x 1 PC

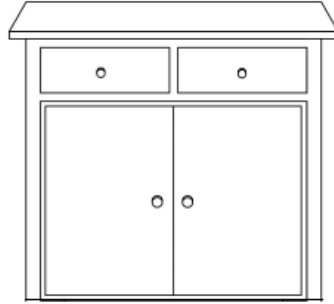

E x 1 PC

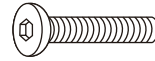

8 x 32 mm

F x 10 PC



8 x 20 mm

H x 10 PC

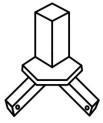

B x 1 PC

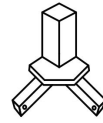

D x 1 PC

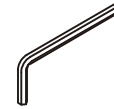

M5

G x 1 PC

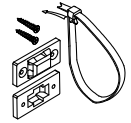

I x 2 PC

STEP 1

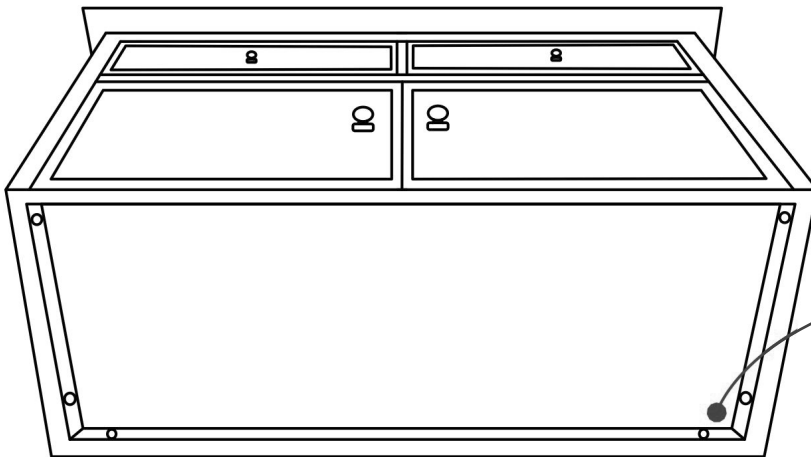

! IMPORTANT

Each leg has a number engraved on the wood, place it in the position with the same number.

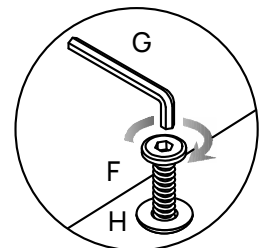
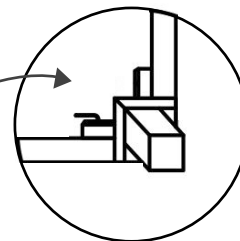

IRAYA

Ref: GN-0019

KLAST

www.klasthome.com

STEP 2

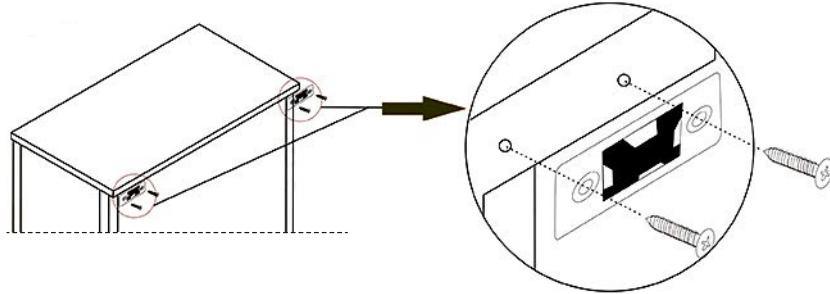

STEP 3

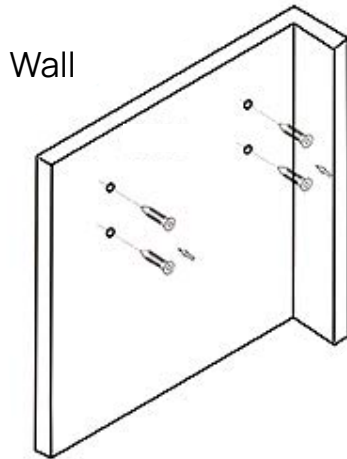

STEP 4

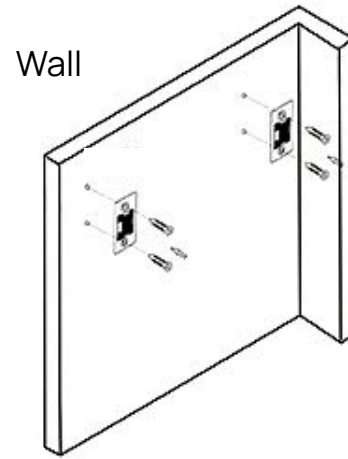

STEP 5

⚠ OBLIGATORY FIX ON THE WALL

The needed hardware for the junction wall/furniture depends of the nature of the wall and is not provide.

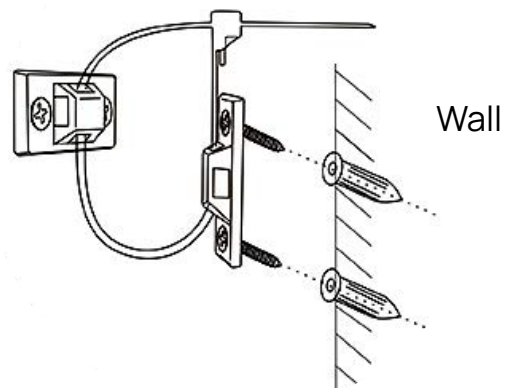

IRAYA

Ref: GN-0019